

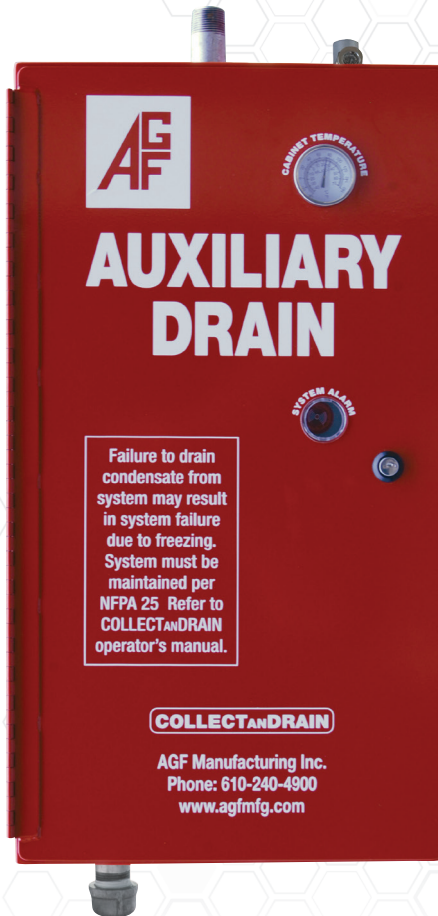

COLLECT_{AN}DRAIN[®]

Model 5400



Failure to drain condensate from system may result in system failure due to freezing. System must be maintained per NFPA 25 Refer to COLLECT_{AN}DRAIN operator's manual.

COLLECT_{AN}DRAIN

AGF Manufacturing Inc.
Phone: 610-240-4900
www.agfmfg.com

Owner's Manual

for Models with Serial Number 5400-1000 and Higher

www.agfmfg.com



COLLECT_{AN}DRAIN[®]

Model 5400

Auxiliary Drain with Freeze Protection

TABLE OF CONTENTS

Model 5400 COLLECT_{AN}DRAIN	3
Installation Instructions	4-7
Unpacking.....	4
Sprinkler System Preparation	4
Mounting Instructions	4
Wiring Instructions	5
Verify Correct Operation	6-7
Operating Instructions	7-9
Power Consumption	8
To Collect Condensate	9
To Drain Condensate	9
Maintenance Instructions	9-11
Verify Alarm Operation.....	10
Verify Heater Operation (M5400A/B)	10
Verify Heater and HOT Monitor Operation (M5400H).....	10
Change Timer Setting (M5400H)	11
Change Thermostat Setting.....	11

AGF Manufacturing

100 Quaker Lane • Malvern, PA 19355

Phone: 610-240-4900
techsupport@agfmfg.com

www.agfmfg.com

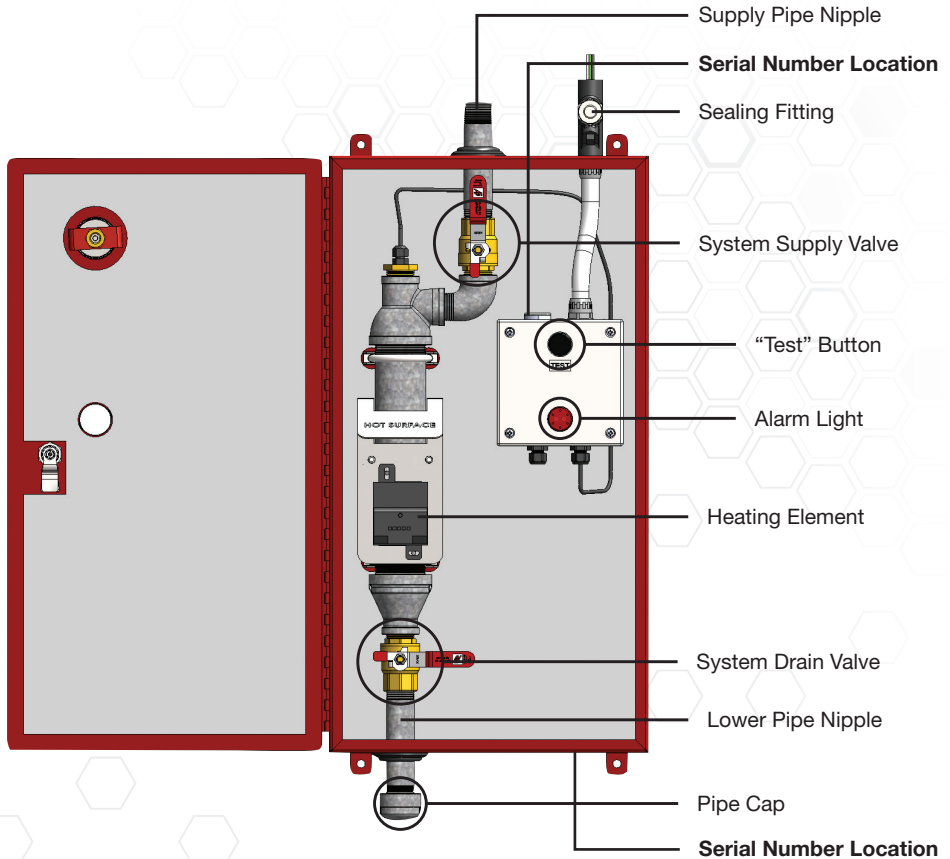

Model 5400 COLLECT_{AND}DRAIN

The COLLECT_{AND}DRAIN Model 5400 is a heated and insulated auxiliary drain (condensation collection assembly, drum-drip, or low-point drain) with float switch and alarm for dry pipe fire sprinkler systems. The Model 5400 is designed for installation in climates where freezing temperatures are present and often results in the failure of typical auxiliary drains. The Model 5400 maintains a comfortable temperature above freezing while minimizing power consumption.

CAUTION: The heater and its deflector bracket may be hot. Use care when accessing the main cabinet for any reason.

INSTALLATION INSTRUCTIONS

Unpacking:

1. Unpack the COLLECT_{AN}DRAIN Model 5400 unit and carefully inspect for any shipping damage.
2. Verify box contents:
 - COLLECT_{AN}DRAIN Model 5400 unit
 - Four (4) Rubber Mounting Washers
 - Two (2) Door Keys
 - Electrical Wiring Schematic
 - Model 5400 System Drawing

Sprinkler System Preparation:

If the installation is replacing an existing auxiliary drain follow the instructions below prior to proceeding to the Mounting Instructions.

1. Isolate the zone where the COLLECT_{AN}DRAIN will be installed.
2. Relieve air pressure from the branch line.
3. Remove the existing auxiliary drain.

Mounting Instructions:

NOTE: For installation locations exposed to weather, the Model 5680A Outdoor Cover is **REQUIRED**. For exposed installations on columns, uneven or curved surfaces, or where cabinets need to stand off the wall to accommodate surface mounted drain pipe, the Model 5690A Mounting Kit may also be required.

Use the mounting tabs (4 - 3/8" holes) to mount the Model 5400 to a wall or other structure. If the wall is uneven, use bushings or stand-offs to prevent the cabinet from warping when mounted.

1. Place the four (4) rubber washers behind the mounting tabs. Use mounting hardware (not provided) capable of supporting the 55 lb. weight of the Model 5400 cabinet.
2. Connect the 1" NPT system supply pipe in accordance with NFPA 13 referencing low-point drain installations.
3. Confirm that the upper valve (supply valve) is in the open position (vertical) ready to collect condensation, the lower valve (drain valve) is in the closed position (horizontal), and the pipe cap is tight.

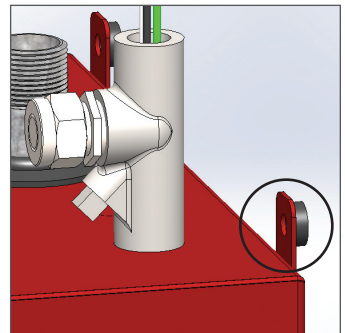

Wiring Instructions:

The Model 5400 is wired with 12 AWG power leads and is protected by an internal 3A circuit breaker that requires a 120VAC power source. Ensure the breaker in the main electrical panel is sized appropriately.

Warning: The Model 5400 comes with power leads wired through a sealed drain fitting per NEC 300.7 (A) "Raceways Exposed to Different Temperatures". If wiring is added or changed in the control panel, NEC 300.7 (A) requires the electrical conduit to be filled with an approved material after the wiring is complete. An approved sealant, sealing fitting, or low-point junction box must be installed at the cabinet coupling. Failure to do so risks condensation intrusion in the control panel resulting in potential system failure and will void all warranties.

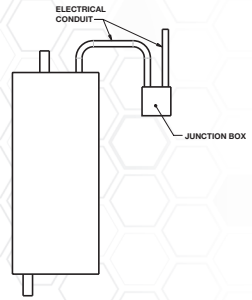

1. Install a low-point junction box within reach of the provided power leads.
2. Run conduit to the ½" fitting on the top of the unit. Pull power leads through conduit and connect leads to wiring from the main electrical panel.
3. To turn the unit on, loosen the four (4) screws on the control panel cover and carefully remove the cover. Then, push the internal circuit breaker up. The breaker indicator will change from green to red.
4. Confirm operation by pushing the "TEST" button on the cover. The alarm will sound, the LED will flash, and dry contacts will close.

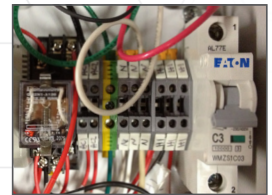

M5400A/B

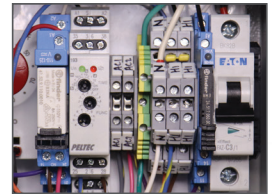

M5400H

The Model 5400 can be connected to a fire panel or building management system (BMS) to remotely notify when it needs to be drained, or if it loses electrical power. This is accomplished through a set of N.O. (close on alarm) auxiliary contacts.

NOTE: If required, an additional port and knockout are provided in the panel and cabinet for a low-voltage wire. **Ensure installer-provided items are liquid tight and the conduit is internally sealed per NEC 300.7 (A).**

1. Run two (2) additional wires into the Model 5400 control panel.
2. Connect one (1) wire to the AC1 (auxiliary contact) terminal.
3. Connect one (1) wire to the AC2 (auxiliary contact) terminal.
4. Connect both wires to the appropriate terminals in the fire panel or BMS.

Verify Correct Operation:

If you are installing the standard Model 5400 please verify the correct operation using the instructions below. If you are installing a model with the optional Heater Operation Trouble (HOT) monitor, please verify correct operation using Model 5400H instructions. If the model is not specifically known, refer to images on page 5 for proper verification.

Model 5400A/B

1. Apply power to the unit and verify that the correct voltage is present.
2. Turn on the circuit breaker inside of the control panel.
3. Push and hold the "TEST" button on the front of the control panel for five (5) seconds to verify that the audible alarm sounds and the LED blinks.
4. Turn thermostat set-point dial (red) clockwise until the heater turns on.
5. Reset thermostat to the factory default of 60° F.

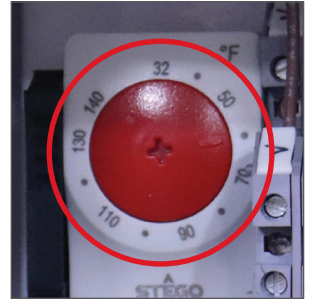

NOTE: It is the owner's responsibility to set the thermostat based on climate conditions of the unit's installation location. The default setting of 60° F (the dot between the 50 and 70) is recommended for outside temperatures down to 0° F. If operating below 0° F the set point should be increased. Consult AGF for set point guidelines.

6. Install the control panel cover and tighten the four (4) screws.
7. Close and lock the cabinet door using the supplied keys.

NOTE: If installation is to an existing system, return the system back to normal operating condition. If installation is to a new system, activate the system for normal operating condition.

Model 5400H

1. Apply power to the unit and verify that the correct voltage is present.
2. Turn on the circuit breaker inside of the control panel.
3. Push and hold the “TEST” button on the front of the control panel for five (5) seconds to verify that the audible alarm sounds and the LED blinks.
4. Turn the top dial of the timer counterclockwise from the **10h** (Fig. 1) to the **10s** (Fig. 2) band. The leg of the cross with the arrow (highlighted in red) points to the band.

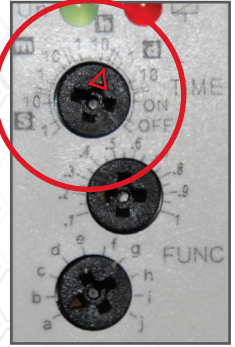

Fig. 1

5. Turn the thermostat set-point dial (red) clockwise until the heater turns on.

NOTE: The alarm will sound approximately 2 seconds after the heater turns on.

6. Reset the thermostat set-point dial (red) to the factory default of 60°F and reset the top dial of the timer to the **10h** (Fig. 1) band.

NOTE: The Top Dial is a maximum time setting and NOT the timer’s delay setting. The middle dial controls the exact amount of delay for the timer. The factory default is 2 hours.

7. Install the control panel cover and tighten the four (4) screws.

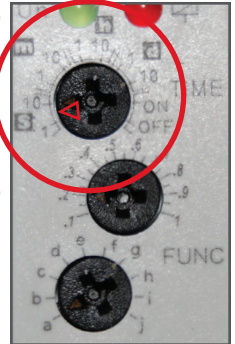

Fig. 2

8. Close and lock the cabinet door using the supplied keys.

OPERATING INSTRUCTIONS

The 150W heater is controlled by a user-set thermostat. The factory default setting of 60° F is recommended for temperatures down to 0° F. Consult AGF for thermostat settings if operating in an environment below 0° F. The thermostat controls the heater operation to within approximately $\pm 10^\circ$ F of the set point (example: if the set point is 60° F: heater ON @ 50° F, heater OFF @ 70° F).

NOTE: AGF does not recommend setting the thermostat below 60° F.

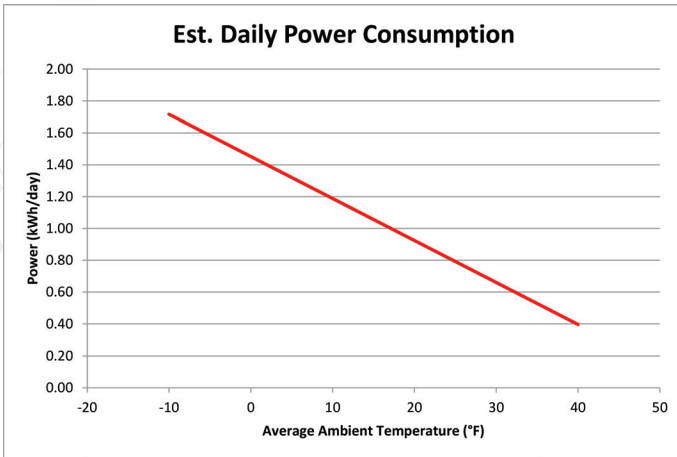

Power consumption is based on several factors including ambient temperature, humidity, installation location, and exposure to sunlight. The graph shows an estimation of the daily energy consumption versus ambient temperature when the set point is 60° F.

The Model 5400 features a thermometer on the cabinet door for monitoring the ambient temperature inside the cabinet to check the operating status of the internal heater. The reading on the thermometer, based on its location in the cabinet, may range from 40° to 120° F depending on when the thermostat is checked during the heater's cycle.

The Model 5400 uses a float switch that monitors the water level in the collection assembly. When enough water has accumulated in the collection assembly the float switch activates a local, audible alarm and a visual LED on the front of the cabinet will blink. This is to notify personnel that the collection assembly's water level is too high and it needs to be drained. The alarm will reset when the water level is drained below the float switch. The Model 5400 can be wired to a fire panel or building management system (BMS) for remote notification.

The Model 5400 is equipped with a "TEST" button to confirm the unit is operating properly. When pressed the audible alarm and visual LED should sound and blink and, if utilized, trip the fire panel or BMS.

The Model 5400H features a Heater Operation Trouble (HOT) monitor that verifies the operation of the heater. If the cabinet door has been left open or the heater is not keeping up with the thermostat's demand, the HOT monitor will activate the local, audible alarm and the LED; and if utilized, trip the fire panel or BMS.

To Collect Condensate per NFPA 25:

1. Open the cabinet door using the supplied keys.
2. Close the lower valve (drain valve).
3. Install the 1" pipe cap onto the pipe at the bottom of the cabinet. Hold the pipe secure with a wrench when installing the pipe cap.
4. Open the upper valve (supply valve).
5. Close and lock the cabinet door using the supplied keys.

To Drain Condensate per NFPA 25:

1. Open the cabinet door using the supplied keys.
2. Close the upper valve (supply valve).
3. Remove the 1" pipe cap from the pipe at the bottom of the cabinet. Hold the pipe secure with a wrench when removing the pipe cap.
4. Open the lower valve (drain valve) and drain the main collection assembly.
5. Once all the water has been drained, close the lower valve (drain valve).
6. Open the upper valve (supply valve) and allow time for any additional water to accumulate.
7. Repeat the drain process until all water has been drained.
8. Once all water has been drained, close the lower valve (drain valve). Install the pipe cap by holding the pipe secure with a wrench. Then, open the upper valve (supply valve).
9. Close and lock the cabinet door using the supplied keys.

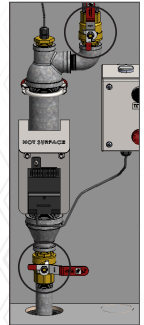

COLLECT

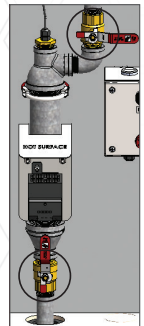

DRAIN

MAINTENANCE INSTRUCTIONS

Regular maintenance is required to keep the unit operating correctly. It is the owner's responsibility to make sure the unit is drained and the heater and alarm are functioning properly. Failure to drain condensation from the system or conduct regular testing and maintenance could result in system failure. The system must be maintained per NFPA 25. It is especially important to keep the unit maintained during the winter season when temperatures are near, or below freezing.

Verify Alarm Operation:

Push and hold the “TEST” button on the control panel for five (5) seconds to verify that the alarm sounds and the LED blinks.

MODEL 5400A/B

Verify Heater Operation:

CAUTION: Always take the necessary precautions while entering the control panel when 120V power is present.

1. Loosen the four (4) screws on the front of the control panel and carefully remove the cover.
2. Take note of the current thermostat set point. Unit default is 60° F.
3. Turn the thermostat set-point dial (red) clockwise until the heater turns on.
4. Reset thermostat set-point dial (red) to the previous set point.
5. Install the control panel cover and tighten the screws.

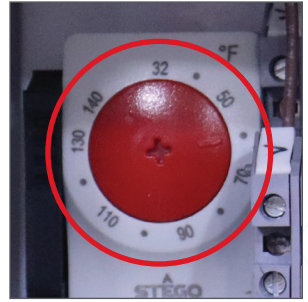

MODEL 5400H

Verify Heater and Hot Monitor Timer Operation:

CAUTION: Always take the necessary precautions while entering the control panel when 120V power is present.

1. Loosen the four (4) screws on the front of the control panel and carefully remove the cover.
2. Take note of the current thermostat set point. Unit default is 60° F.
3. Take note of the current time band (top dial). The leg of the cross with the arrow points to the band.
4. Turn the top dial to the **10s** band.
5. Turn the thermostat set-point dial (red) clockwise until the heater turns on.

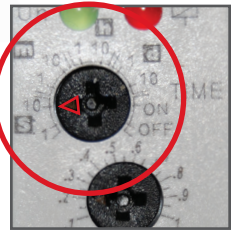

- NOTE:** The alarm will sound a few seconds after the heater turns on.
6. Reset the red thermostat set-point dial (red) to the previous set point.
 7. Reset the time band (top dial) to the previous setting. The leg of the cross with the arrow points to the band.
 8. Install the control panel cover and tighten the screws.

Change Timer Setting (M5400H Only):

NOTE: It is the owner's responsibility to set the timer based on the climate conditions of the unit's installed location. The default setting of 2 hours is adequate for outside temperatures down to 0° F.

1. Disconnect power to the unit.
2. Loosen the four (4) screws on the control panel and carefully remove the cover.
3. Turn the middle dial to the desired number of hours. The leg of the cross with the arrow (highlighted in red) indicates the setting.

IMPORTANT: Unless you are testing the system changing the top dial time band from **10h** is NOT recommended. The bottom dial should NEVER be changed from the "a" setting.

4. Install the control panel cover and tighten the screws.
5. Restore power to the unit.
6. Verify the unit has power by pressing and holding the "TEST" button.



Change Thermostat Setting:

NOTE: It is the owner's responsibility to set the thermostat based on the climate conditions of the unit's installed location. The default setting of 60° F (the dot between 50 and 70) is adequate for outside temperatures down to 0° F. If operating below this temperature the set point should be increased. Consult AGF for set point guidelines.

1. Disconnect electrical power to the unit.
2. Loosen the four (4) screws on the control panel and carefully remove the cover.
3. Turn the thermostat set-point dial clockwise or counterclockwise to the desired setting.
4. Install the control panel cover and tight the screws.
5. Restore power to the unit.
6. Verify the unit has power by pressing and holding the "TEST" button.





AGF Manufacturing
100 Quaker Lane • Malvern, PA 19355

Phone: 610-240-4900
techsupport@agfmfg.com

www.agfmfg.com